



OPTIKA CAMERA ADAPTERS

Connection Guide

Table of contents

1. The selection of the C-mount adapter p. 3

1.1 Selecting the C-mount adapter p. 3

1.2 Percentage of field framed according to eyepieces p. 5

1.3 How to calculate the final magnification on the monitor p. 6

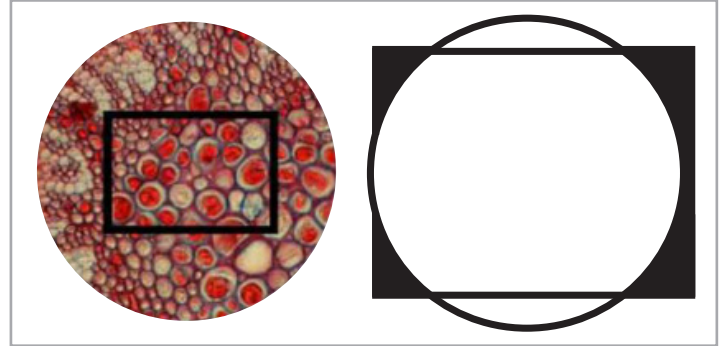

2. C-mount cameras p. 7

2.1 Connect a C-mount camera to a biological microscope p. 7

2.2 Connect a C-mount camera to a stereomicroscope p. 8

2.3 Adjusting parfocality between eyepiece and on-screen images p. 9



SLX / SZM / SZN / SZP



3. Eyepiece cameras p. 10

3.1 Connect a C-mount camera to a trinocular microscope p. 10

3.2 Connect a C-mount camera to a monocular/binocular microscope p. 11



4. Reflex cameras p. 11

4.1 Connect a Reflex camera to a trinocular microscope (using a projection lens) p. 11-12



5. Sensor adapters chart p. 14-15

1 The selection of the C-mount adapter

1.1 Selecting the C-mount adapter

When the users look inside the eyepieces, at a glance they are able to obtain a good perception of what is observed, quickly evaluating the sample.

When the image is projected to a monitor/screen, the situation is different: people is often expecting to have the exact correspondence between what is observed into the eyepieces and what is projected on the screen, but the rule "What You See Is What You Get" is not always applicable in digital microscopy.

The reason is pretty simple: we are comparing a round image observed in the eyepieces and a rectangular image projected on the monitor/screen...

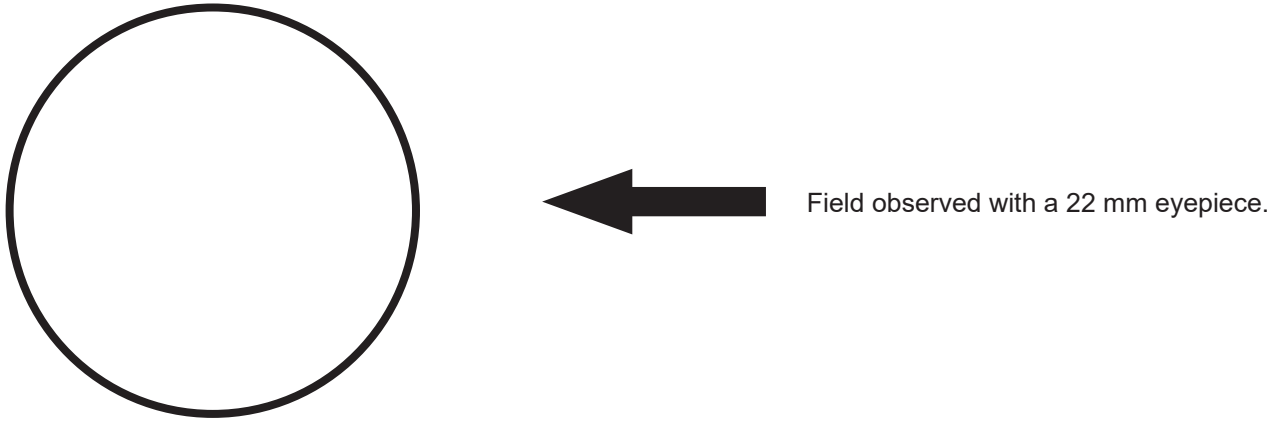

Cameras' sensors are rectangular and the image is a part of what is visible through the eyepieces. Physically, it is not possible to carry out the circle squaring, therefore it is absolutely impossible to frame the whole field observed through the eyepieces, but we have to consider the diagonal of the sensor which varies according to its size.

SENSOR	DIAGONAL (mm)	LENGHT (mm)	HEIGHT (mm)
1/10"	1.60	1.28	0.96
1/8"	2.00	1.60	1.20
1/6"	3.00	2.40	1.80
1/4"	4.00	3.20	2.40
1/3"	6.00	4.80	3.60
1 / 2.3"	7.66	6.17	4.55
1/2"	8.00	6.40	4.80
1 / 1.8"	8.93	7.18	5.32
1 / 1.7"	9.50	7.60	5.70
1 / 1.6"	10.07	8.08	6.01
2/3"	11.00	8.80	6.60
1"	15.86	13.20	8.80
4/3"	21.60	17.30	13

1.1 Selecting the C-mount adapter

It is easy to understand that the rectangle and the circle cannot frame the same portion of the image.

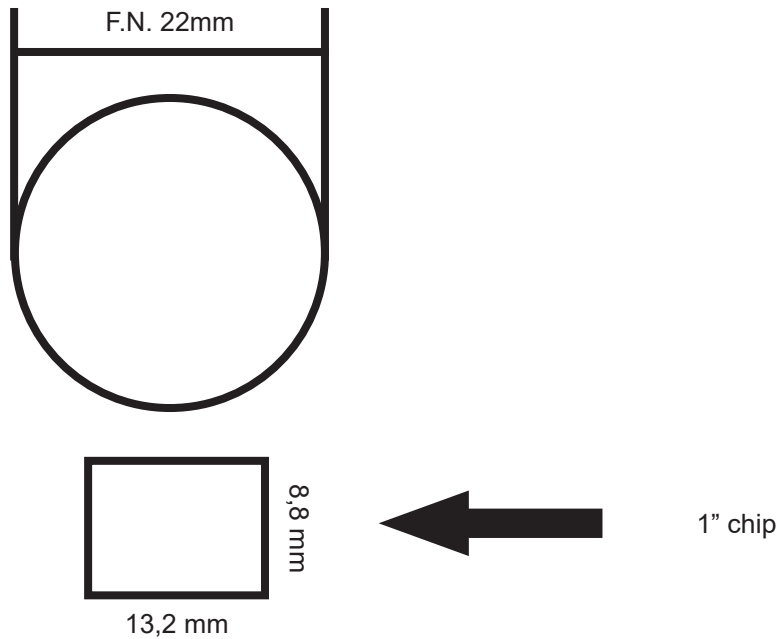

Between microscope and camera it is necessary to put a system, commonly known as “**adapter**”, that can project on the sensor the image coming from the microscope, making it available to focus and to monitor projection. There are several adapters (with various magnification factors) that can enlarge or reduce the microscopic image and make it available for the camera.

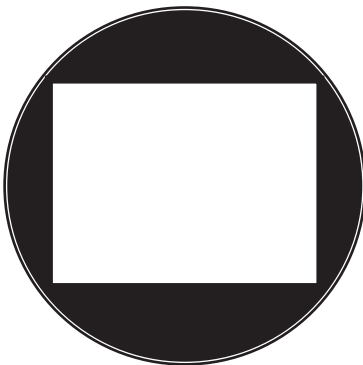

An optimal situation could be to frame all the possible field using the full diagonal of the sensor: in this case, the center of what is observed through the eyepieces will be visible on the monitor/screen, whilst the side parts of the image are lost.

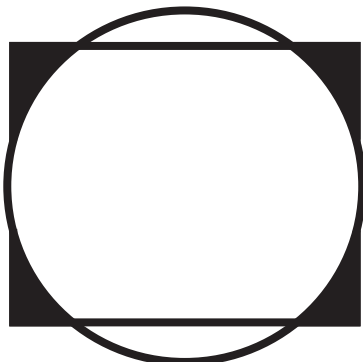

An alternative solution (but not recommended for the final effect on the monitor) is to enlarge the image until the long side of the sensor matches the field of the eyepieces. In this case, the image is “vignetting”, generating black corners.

1.1 Selecting the C-mount adapter

Basically, C-mount adapters are four: 0.35x, 0.5x, 0.65x, 1x.
 These numbers represent the magnification power of each adapter (in terms of %).

0.35x	70%
0.50x	100%
0.65x	132%
1x	200%

Take in consideration that:

- THE HIGHER MAGNIFICATION ON THE SENSOR, THE SMALLER FIELD FRAMED

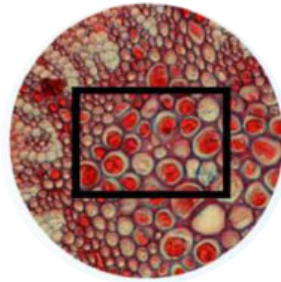

- THE LOWER MAGNIFICATION ON THE SENSOR, THE BIGGER FIELD FRAMED

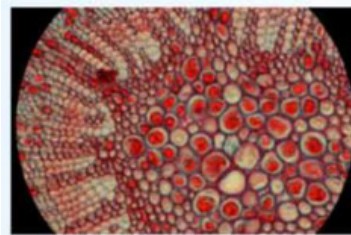

1.2 Percentage of field framed according to eyepieces

Generally, the suggestion is to find the right compromise between what we would like to observe and what we could achieve as a final result.

In order to do that, it is necessary to carefully consider the combination of the camera's sensor and magnification of the C-mount adapter to see which part of the field (also depending on the field number of the eyepieces) the sensor will be able to frame.

The table shows the percentage of field framed when using eyepieces with field number 22.

SENSOR	DIAGONAL (mm)	% field framed
1/10"	1,6	28,6%
1/8"	2	35,8%
1/6"	3	53,7%
1/4"	4	71,6%
1/3"	6	107,4%
1/2.3"	7,66	137,1%
1/2"	8	143,2%
1/1.8"	8,93	159,8%
1/1.7"	9,5	170%
1/1.6"	10,07	180,2%
2/3"	11	196,9%
1"	15,86	283,8%
4/3"	21,6	386,54%

1.3 How to calculate the final magnification on the monitor

Calculating the image magnification on a video monitor can be accomplished first by determining the optical magnification and multiplying it by the electronic magnification.

$$\text{Optical Magnification} = \text{Objective Mag.} * \text{Projection lens or "C-mount adapter Mag.}$$

The objective magnification is expressed as 10x, 20x etc. and Projection lens or "C"-mount adapter is the optical path magnification that leads to the video camera.

Some typical magnification of the "C"-mount adapter are 0.35X, 0.5X, 0.65X, 0.75X, 1X.

$$\text{Electronic Magnification} = \text{Monitor diagonal size} / \text{Camera chip diagonal size}$$

The monitor's diagonal size is usually expressed as 14", 15", 17", 19", 20", 21",...

The camera's chip is expressed as 1/3", 1/2", 2/3" or 1".

However, this is not the dimension we use. We need to use the diagonal dimension of the chip.

The table below represents the common chip sizes and their diagonal dimensions in millimetres and inches.

CHIP SIZE	DIAGONAL (mm)	DIAGONAL (inches)
1/3"	6	0.24
1/2"	8	0.31
2/3"	11	0.43
1"	15,86	0.63

The formula to calculate the final magnification of the image on the monitor is:

$$\text{Objective Mag.} * \text{Projection lens or "C-mount adapter Mag.} * (\text{Monitor diagonal size} / \text{Camera chip diagonal size})$$

Let's make an example:

We have a microscope where a 2/3" camera with a 0.65 "C"-mount adapter is installed and the image is projected on a 21" monitor.

Actually we are using 20x objective

Microscope magnification: 20X (objective) * 10X (eyepiece) = 200X

Camera magnification: 20X (objective) * 0.65X ("C"-mount) * 21" (monitor) / 0.43" (chip size) =
20X * 0.65X * 48.83 = 634,79X

2 C-mount cameras

2.1 Connect a C-mount camera to a biological microscope

Connect a C-mount camera to a trinocular head of the current OPTIKA microscope range:

- B-380, B-510, B-810, B-1000, IM-3 and IM-5 Series



M1) Remove camera's dust cover



M2) Remove C-mount adapter dust cover



M4 / M5) Connect the C-mount on the camera by screwing firmly



M5) Loose the clamping screw



M6) Remove trinocular head's dust cover



M7 / M8) Install the previously assembled C-mount + camera on the trinocular head

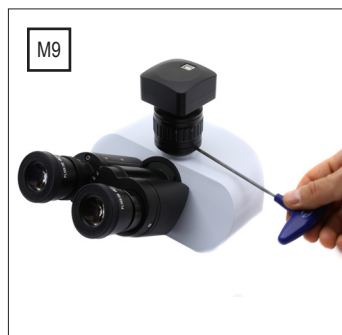

M9) Tighten the clamping screw firmly

2.2 Connect a C-mount camera to a stereomicroscope

Connect a C-mount camera to a trinocular head of the current OPTIKA stereomicroscope range:

- SLX, SZM, SZO, SZP Series



M1) Remove camera's dust cover



M2) Remove C-mount adapter dust cover



M4 / M5) Connect the C-mount on the camera by screwing firmly



M5) Loose the clamping screw



M6) Remove trinocular head's dust cover



M7 / M8) Install the previously assembled C-mount + camera on the trinocular head



M9) Tighten the clamping screw firmly

2.3 Adjusting parfocality between eyepiece and on-screen images

In order to have the same focus when observing the specimen through the eyepieces and on the screen/monitor, please verify the microscope is properly installed and set and follow the instructions below.

In case of a biological microscope:

- 1) Use a low power objective and focus the specimen;
- 2) Switch to the highest dry objective available on the microscope (40x or 60x) and focus the specimen again;
- 3) Turn on the live-view on the camera, without changing the focus on the microscope;
- 4) While observing the image on the screen/monitor, adjust the focus by turning the knurled knob on the C-mount adapter

In case of a stereomicroscope:

- 1) Using a low power magnification and focus the specimen;
- 2) Reach the highest magnification available using the zoom knob and then focus the specimen again;
- 3) Turn on the live-view on the camera, without changing the focus on the microscope;
- 4) While observing the image on the screen/monitor, adjust the focus by turning the knurled knob on the C-mount adapter

The proper parfocality adjustment is obtained when the same focus is reached when looking into the eyepieces and on the screen/monitor.



F1 / F2 / F3) While observing the image on the screen/monitor, adjust the focus by turning the knurled knob on the C-mount adapter



F4 / F5) Loose the clamping knob of the 1x C-mount adapter



F6) While observing the image on the screen/monitor, adjust the focus by turning the knurled knob on the C-mount adapter



F7) Tighten the clamping knob on the 1x C-mount adapter

3 Eyepiece cameras

3.1 Connect a C-mount camera to a trinocular microscope

Connect a camera to a trinocular head of the current OPTIKA microscope and stereomicroscope range using the C-mount projection lens:

- B-193, B-293

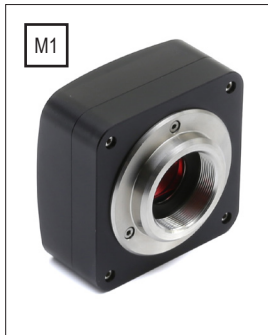

M1) Remove camera's dust cover



M2) Remove C-mount projection lens' dust cover



M3 / M4) Connect the C-mount projection lens on the camera by screwing firmly



M5) Connect the C-mount projection lens on the trinocular port

3.2 Connect a C-mount camera to a monocular/binocular microscope

Connect a camera to a binocular or monocular head of the current OPTIKA microscope and stereomicroscope range using the C-mount projection lens:

- Any OPTIKA monocular or binocular microscope/stereomicroscope
- Any non-OPTIKA monocular or binocular microscope/stereomicroscope

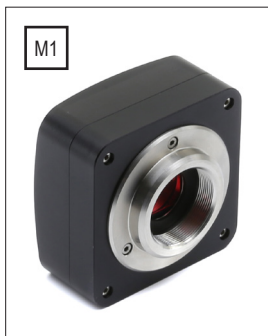

M1) Remove camera's dust cover



M2) Remove C-mount projection lens' dust cover



M3 / M4) Connect the C-mount projection lens on the camera by screwing firmly



M5) Remove an eyepiece



M6) Connect the C-mount projection lens where the eyepiece has been removed



M7) Properly install the camera



M8 / M9) For eyepiece sleeves bigger than 23 mm, use the adapter ring (23 to 30 mm or 23 to 30.5 mm, according to the sleeve size, both are supplied)

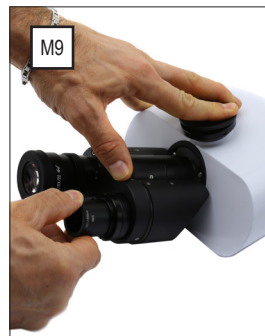

4 Reflex cameras

4.1 Connect a Reflex camera to a trinocular microscope

Connect a Reflex camera to a trinocular head of the current OPTIKA microscope and stereomicroscope range using the projection lens:

- B-193, B-293



M1) Screw the Reflex adapter to the "T2" ring (provided with the Reflex camera or from its manufacturer)



M2) Connect the Reflex camera's adapter with the "T2" ring



M3) Properly install the Reflex camera's adapter on the trinocular port

4.1 Connect a Reflex camera to a trinocular microscope

Connect a Reflex camera to a trinocular head of the current OPTIKA microscope and stereomicroscope range using the projection lens plus the universal adapter:

- B-380, B-510, B-810, B-1000, IM-3, IM-5, SZM, SZN, SZP series



M1) Screw the small ring adapter into the universal adapter



M2) Clamp the bottom part of the Reflex adapter with the universal adapter



M3) Screw the Reflex adapter to the "T2" ring (provided with the Reflex camera or from its manufacturer)



M4) Follow instructions M5 - M9 described in chapter 2.1

5. Sensor adapters chart

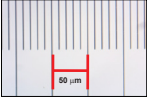
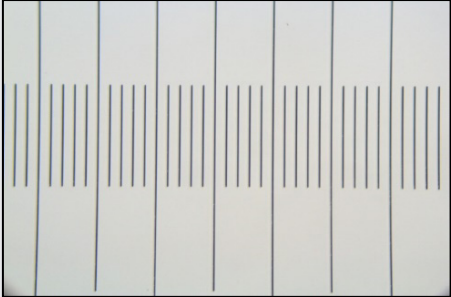
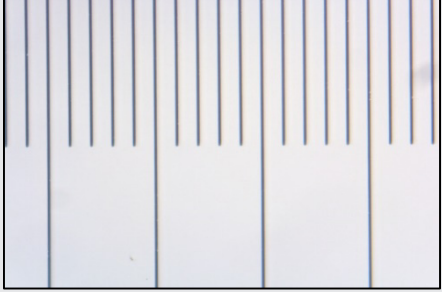
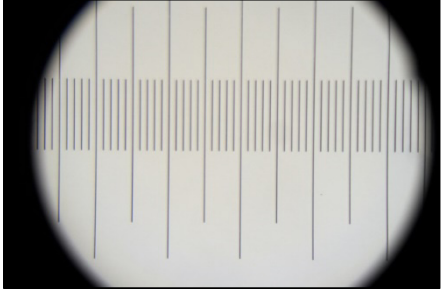
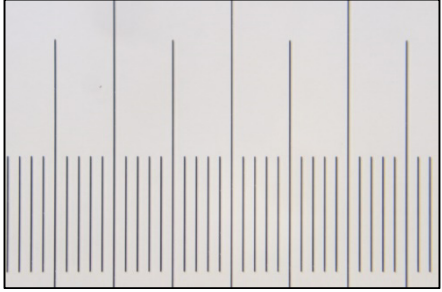
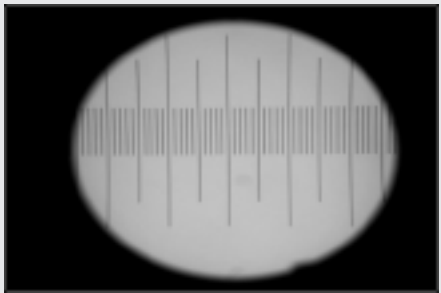
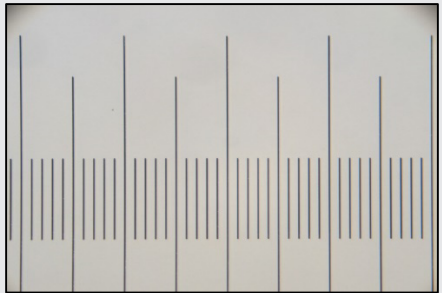
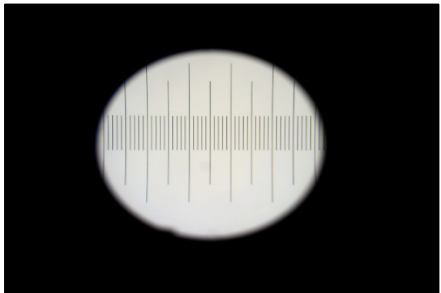
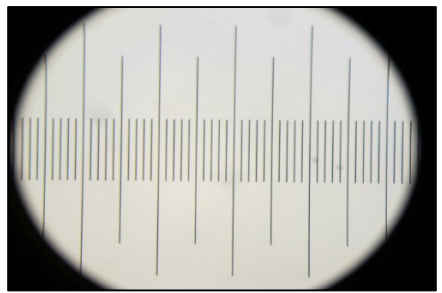
Reference model	Microscope: B-1000BF Objective: 40x	Sample: micrometer object Field to the eyepieces: 530 μm	
SENSOR ADAPTER	0,35X (M-620)		0,5X (M-620.1)
<p>1/3" (1/3" → 1/2,6")</p>			
<p>1/2" (1/2,5" → 1/1,8")</p>			
<p>2/3"</p>			
<p>1"</p>			

0,65X
(M-620.2)

1X
(M-620.3)

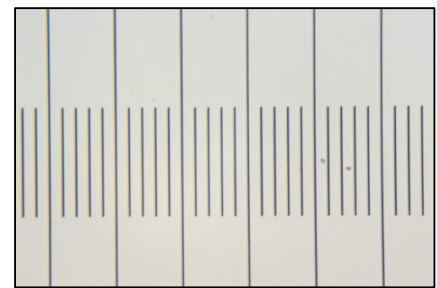
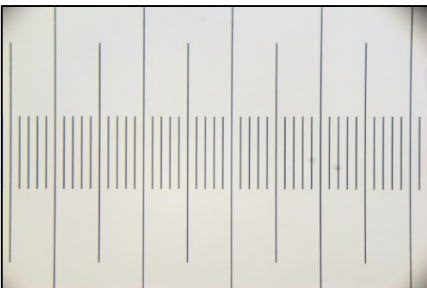
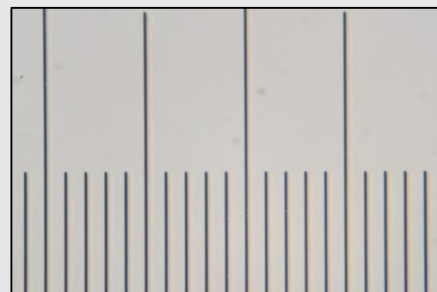
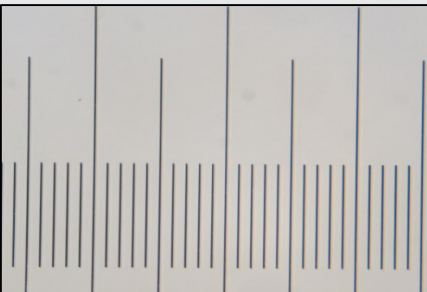
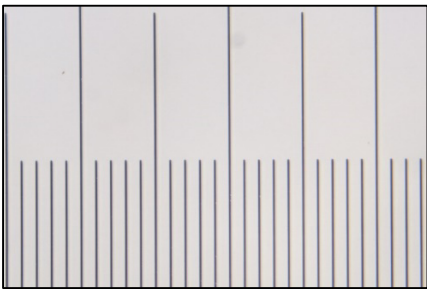
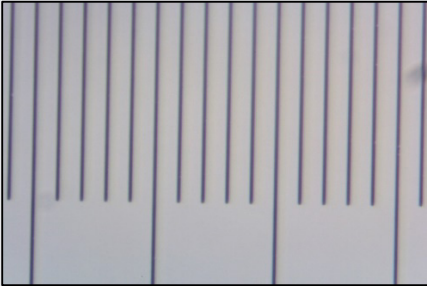

v 1.0.0 - OPTIKA reserves the right to make corrections, modifications, enhancements, improvements and other changes to its products at any time without notice.

Headquarters and Manufacturing Facilities

OPTIKA® S.r.l. Via Rigla, 30 - 24010 Ponteranica (BG) - ITALY - Tel.: +39 035.571.392 - info@optikamicroscopes.com

Optika Sales branches

OPTIKA® Spain spain@optikamicroscopes.com
OPTIKA® China china@optikamicroscopes.com
OPTIKA® India india@optikamicroscopes.com

OPTIKA® USA usa@optikamicroscopes.com
OPTIKA® Central America america@optikamicroscopes.com